



THREE-CD CHANGER
MINI-COMPACT SYSTEM
CD-R/RW PLAYBACK
MAX-B550/B570



Instruction Manual



Safety Warnings

GB

CLASS 1 LASER PRODUCT
KLASSE 1 LASER PRODUKT
LUOKAN 1 LASER LAITE
KLASS 1 LASER APPARAT
PRODUCTO LASER CLASE 1

	CAUTION RISK OF ELECTRIC SHOCK. DO NOT OPEN	
<p>CAUTION: TO REDUCE THE RISK OF ELECTRIC SHOCK, DO NOT REMOVE REAR COVER. NO USER SERVICEABLE PARTS INSIDE. REFER SERVICING TO QUALIFIED SERVICE PERSONNEL.</p>		

CLASS 1 LASER PRODUCT
This Compact Disc player is classified as a CLASS 1 LASER product.

Use of controls, adjustments or performance of procedures other than those specified herein may result in hazardous radiation exposure.

CAUTION-INVISIBLE LASER RADIATION WHEN OPEN AND INTERLOCKS DEFEATED, AVOID EXPOSURE TO BEAM.



This symbol indicates that dangerous voltage which can cause electric shock is present inside this unit.



This symbol alerts you to important operating and maintenance instructions accompanying the unit.

WARNING: To reduce the risk of fire or electric shock, do not expose this appliance to rain or moisture.

CAUTION: TO PREVENT ELECTRIC SHOCK, MATCH WIDE BLADE OF PLUG TO WIDE SLOT, FULLY INSERT.

Contents

Thank you for buying this
SAMSUNG mini-compact system.

Please take time to read these instructions.
They will allow you to operate your
system with ease and take full advantage
of its features.



- ◆ SAFETY WARNINGS 2
- ◆ INSTALLING YOUR MINI-COMPACT SYSTEM 4
 - Front Panel View 4
 - Remote Control 5
 - Rear Panel View 6
 - Where to Install Your Mini-Compact System 7
 - Connecting your System to the Power Supply 7
 - Inserting Remote Control Batteries 7
 - Connecting to an External Source 8
 - Connecting the Loudspeakers 8
 - Connecting the AM (MW)/LW Aerial 9
 - Connecting the SW Aerial (option) 9
 - Connecting the FM Aerial 9
 - Demo/Dimmer function 10
 - Setting the Clock 10
- ◆ CD-PLAYER 11
 - Loading and Changing Compact Discs 11
 - Listening to a Compact Disc 11
 - Selecting a Disc in the CD changer 12
 - Selecting a Track 12
 - Searching for a Specific Music Passage on a CD 12
 - Shuffle Play Function 12
 - Repeating One or All Tracks on the Compact Discs 13
 - Programming the Order of Playback 13
 - Checking or Changing Programmed Tracks 14
- ◆ TUNER 14
 - Searching for and Storing the Radio Stations 14
 - Selecting a Stored Station 15
 - Improving Radio Reception 15
- ◆ TAPE DECK 16
 - Listening to a Cassette 16
 - CD Synchro Record Feature 16
 - Recording a Compact Disc 16
 - Recording a Radio Program 17
 - Copying a Cassette (Dubbing) 17
 - Selecting the Cassette Playback Mode (Deck 2 Only) 17
 - Tape Counter 17
- ◆ OTHER FUNCTIONS 18
 - Timer Function 18
 - Cancelling the Timer 18
 - Mute Function 19
 - Power Surround Function 19
 - Selecting Sound Mode 19
 - Setting the System to Switch off Automatically 20
 - Super Bass Level 20
 - Connecting Headphones 20
 - Microphone Function (option) 20
- ◆ RECOMMENDATIONS FOR USE 21
 - Safety Precautions 21
 - Cleaning Your Mini-Compact System 21
 - Precautions When Using Compact Discs 22
 - Precautions When Using Audio Cassettes 22
 - Before Contacting the After-Sales Service 22
 - Technical Specifications 23

Symbols



Press



Push



Important



Note

Front Panel View

GB

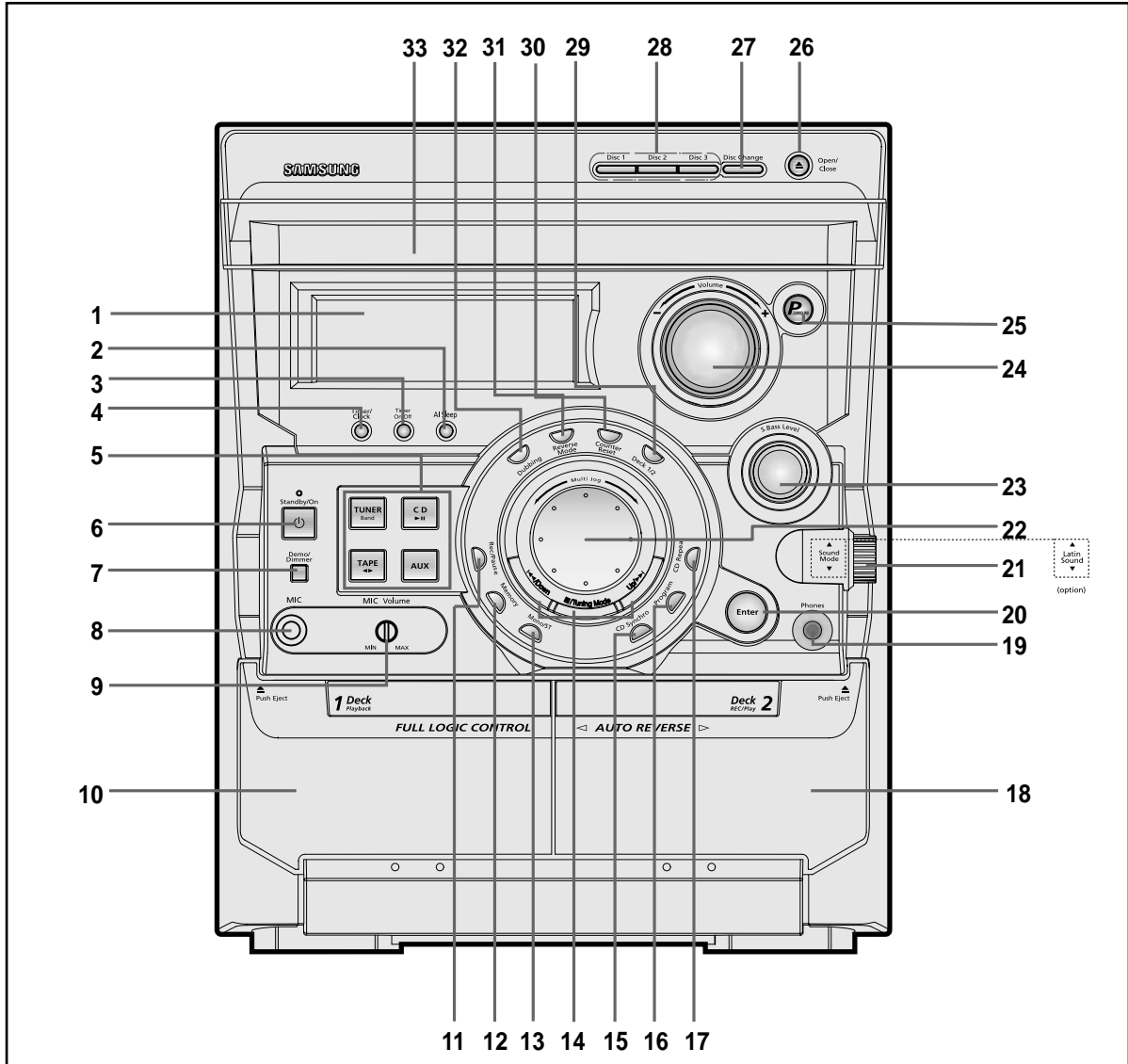

- | | |
|---|--|
| <ol style="list-style-type: none"> 1. Display Window 2. AI Sleep 3. Timer On/Off 4. Timer/Clock 5. Function Selection buttons 6. Standby/On 7. Demo/Dimmer 8. MIC (option) 9. MIC Volume (option) 10. Cassette Deck 1 11. REC/Pause 12. Memory 13. Mono/ST 14. Search Function buttons
Tuning Mode or Stop button 15. CD Synchro Recording 16. Program 17. CD Repeat | <ol style="list-style-type: none"> 18. Cassette Deck 2 19. Headphone Jack Connector 20. Enter 21. Sound Mode or Latin Sound 22. Multi Jog 23. S.BASS Level 24. Volume 25. Power Surround 26. Open/Close 27. Disc Change 28. Disc Selection buttons 29. Deck 1/2 30. Counter Reset 31. Reverse Mode 32. TAPE Normal Speed Dubbing 33. Compact Disc Compartment <p>➤ Latin Sound can be selected in Latin American</p> |
|---|--|



Remote Control

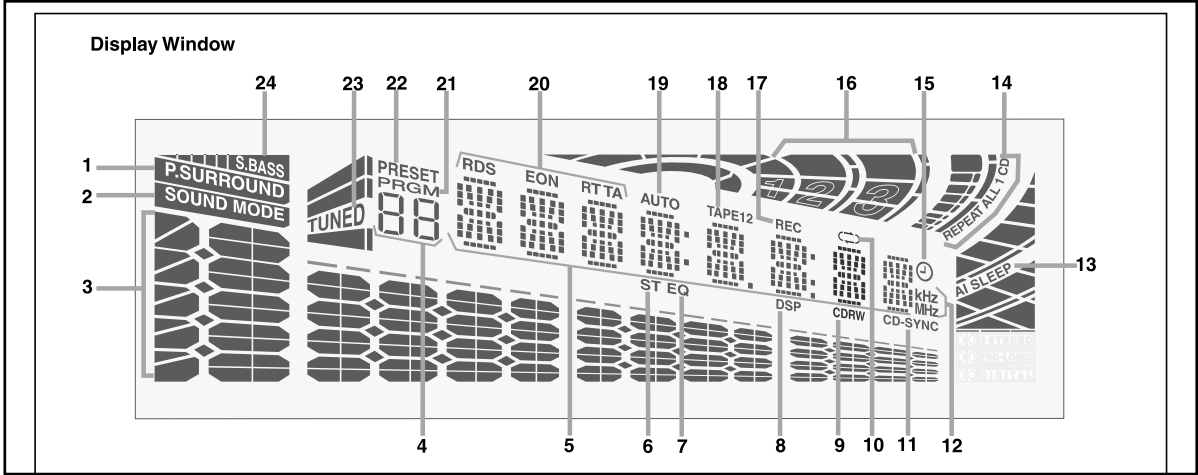

- | | |
|---|---|
| 1. Power Surround | 15. Clock |
| 2. Sound Mode | 16. Playing Disc Number |
| 3. Volume and EQ Level | 17. Recording |
| 4. CD Program and Tuner Preset Number | 18. Tape 1/2 |
| 5. Main Display (Function, Frequency, Time, etc.) | 19. Tuning Mode (Auto) |
| 6. FM Mode (STEREO) | 20. FM RDS Mode |
| 7. EQ | 21. CD Program or Tuner Memory to Program |
| 8. D.S.P | 22. Tuner Preset |
| 9. CD-RW | 23. TUNED |
| 10. Tape Reverse Mode | 24. Super BASS |
| 11. CD Synchro Recording | |
| 12. Tuner Frequency unit | |
| 13. AI SLEEP or SLEEP | |
| 14. CD Playing Disc Mode or CD Repeat Mode | |

Rear Panel View

GB

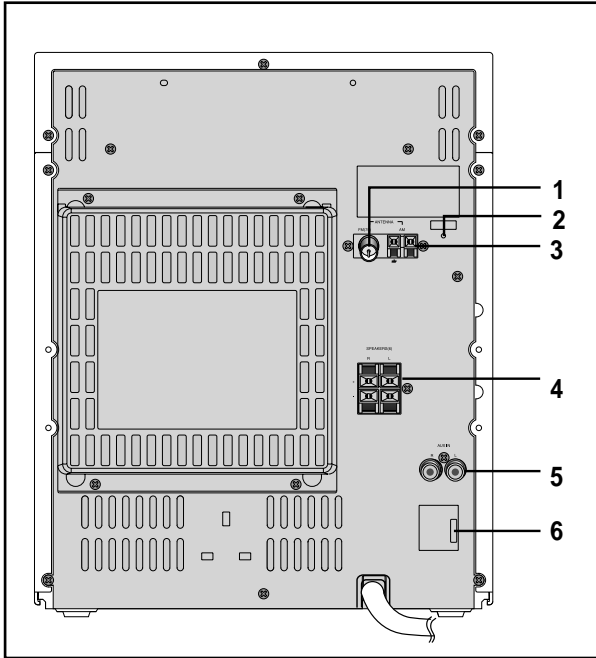

1. FM Aerial Connector Terminal
2. SW Aerial Connector Terminal (option)
3. AM Aerial Connector Terminal
4. Loudspeaker Connector Terminals
5. AUX-Input
6. Voltage selector (option)

Remote Control

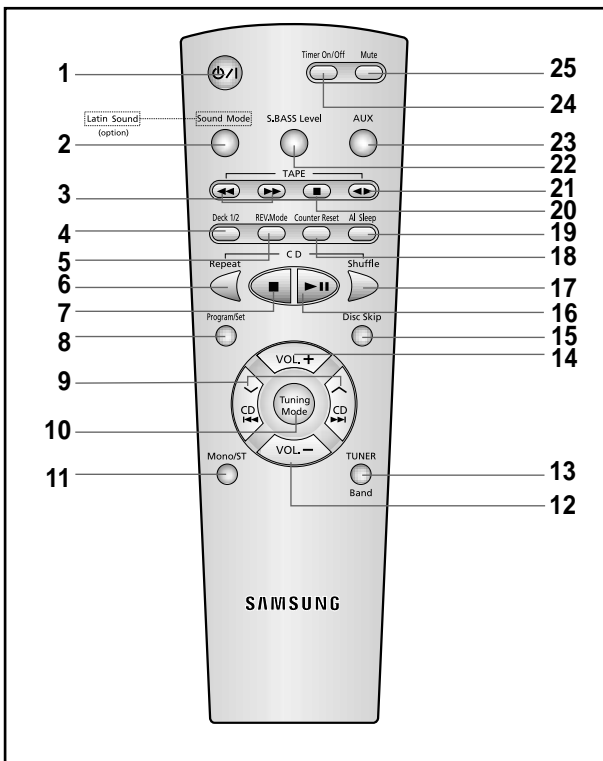

1. Standby/On
2. Sound Mode or Latin Sound
3. TAPE Fast-Forward/ Rewind
4. Deck 1/2
5. Reverse Mode
6. CD Repeat
7. CD Stop
8. Program/Set
9. CD Track or Radio Station Search
10. Tuning Mode
11. FM Mono/Stereo
12. Volume Decrease
13. Tuner Band
14. Volume Increase
15. Disc Skip
16. CD Play/Pause
17. CD Shuffle PLAY
18. Counter Reset
19. AI Sleep
20. TAPE Stop
21. TAPE Play
22. Super Bass Level
23. AUX
24. Timer On/Off
25. Mute

Where to Install Your Mini-Compact System

To take full advantage of your new mini-compact system, follow these installation instructions before connecting the unit.

- ◆ Install the system on a flat, stable surface.
- ◆ Never place this unit on carpeting.
- ◆ Never place this unit in an outdoor area.
- ◆ Maintain an open space of approximately 6 inches (15 cm) on the sides and rear of the system, for ventilation purposes.
- ◆ Make sure that you have enough room to open the compact disc compartment easily.
- ◆ Place the loudspeakers at a reasonable distance on either side of the system to ensure good stereo sound.
- ◆ Direct the loudspeakers towards the listening area.
- ◆ For optimum performance, make sure that both speakers are placed at an equal distance above the floor.

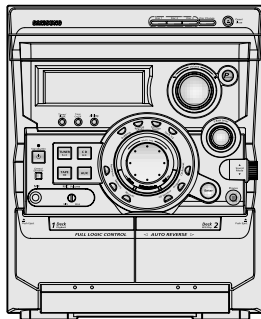

Connecting your System to the Power Supply

The main lead must be plugged into an appropriate socket.

- ☛ Before plugging your system into a main socket, you must check the voltage.

- 1 Check the position of the voltage selector on the rear of the system (OPTIONAL).
- 2 Plug the main lead (marked **AC Cord** on the rear of the system) into an appropriate socket.
- 3 Press the **Standby/On** button to switch your mini-compact system on.

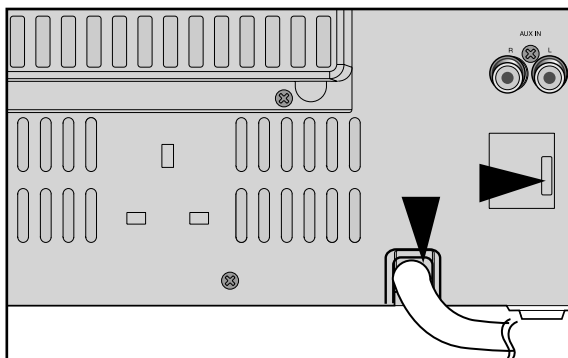

Inserting Remote Control Batteries

GB

Insert or replace remote control batteries when you:

- ◆ Purchase the mini-compact system
- ◆ Find that the remote control is no longer operating correctly

- ☛ When replacing the batteries, use a new set of batteries and never mix alkaline and manganese batteries.

- 1 Place your thumb on the position marked  on the battery compartment cover (rear of the remote control) and push the cover in the direction of the arrow.
- 2 Insert two AAA, LR03 or equivalent batteries, taking care to respect the polarities:
 - ◆ + on the battery against + in the battery compartment
 - ◆ - on the battery against - in the battery compartment
- 3 Replace the cover by sliding it back until it clicks into position.

- If you will not be using the remote control for a long time, remove the batteries to prevent corrosion.

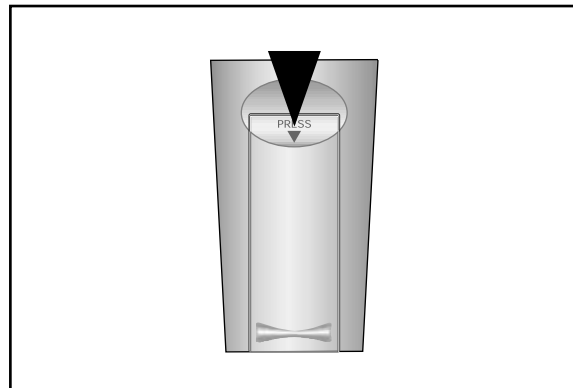

Connecting to an External Source

GB

The auxiliary input can be used to take advantage of the sound quality of your mini-compact system when listening to other sources.

- Examples:**
- ◆ A television
 - ◆ A video disc player
 - ◆ A Hi-Fi stereo video cassette recorder

➤ To connect the external source, the source must have an audio output. In addition, you need an RCA connection cable.

1 Set the system to standby mode and disconnect it and the external source from the main.

2 Connect the audio cable to the rear of the mini-compact system.

Connect the...	To the connector marked...
Red jack	R (right)
White jack	L (left)

➤ For optimum sound quality, do not invert the right and left channels.

3 Plug the system back into the main socket and press **Standby/On** to switch it on.

4 Select the AUX source by pressing **AUX**.
Result: **AUX** is displayed.

5 Switch the external source on.

6 Adjust the volume and balance as required:
◆ Volume ◆ Equalizer

Example: You can watch a film and take advantage of stereo sound provided that the original sound track is in stereo (as if you were in a cinema).

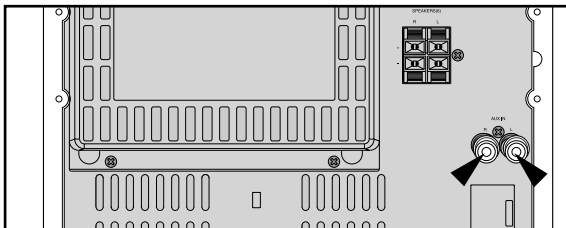

Connecting the Loudspeakers

The loudspeaker connector terminals are located on the rear of the system.

There are four terminals on the system:

- ◆ Two for the left speaker (marked L)
- ◆ Two for the right speaker (marked R)

To achieve the correct sound quality, connect the:

- ◆ Red wire to the + terminals
- ◆ Black wire to the - terminals

1 To connect a wire to a terminal, push the tab as far as it will go:
◆ To the right on the system

2 Insert the wire, up to the plastic sheathing, in the hole.

3 Push the tab back:
◆ To the left on the system, until it clicks into place
◆ To the top on the loudspeaker
Result: The wire is pinched and held firmly in place.

4 Repeat the operation for each wire.

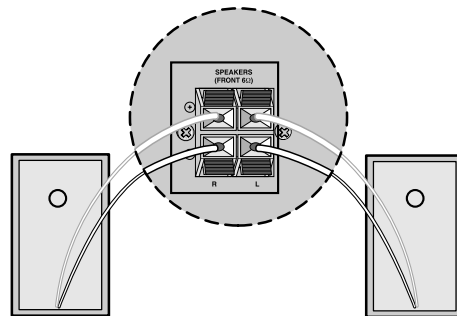

Directions in Installing Speaker

- ◆ Installation in a place near heating apparatus, under direct lay of light or with high humidity may cause performance degradation of the speaker.
- ◆ Do not install on the wall or on a high place of pole or other unstable place to prevent any safety accident caused by falling of the speaker.
- ◆ Do not take the speaker apart from TV or computer monitor. The speaker near the TV or computer monitor may influence the quality of the screen display.

Connecting the AM (MW)/LW Aerial

The AM aerial (for long and medium waves) can be:

- ◆ Placed on a stable surface
- ◆ Fixed to the wall (you must first remove the base)

The **AM** aerial connector terminals are located on the rear of the system and are marked **AM**.

- ☛ To avoid noise interference, check that the loudspeaker wires do not run close to the aerial wires. Always keep them at least 2 inches (5 cm) away.

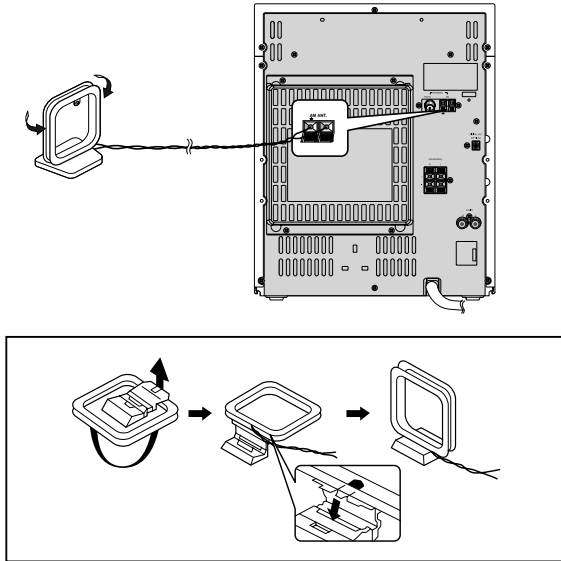

Connecting the FM Aerial

How to connect a COAXIAL TYPE aerial.

- ◆ Connect a 75Ω antenna to the **FM** antenna terminal.
- ◆ Plug the connector on the **FM** aerial supplied into the coaxial socket (75Ω) marked **FM** on the rear of the system.
- ◆ Follow the instructions given on Page 14 to tune into a radio station, and determine the best position for the aerial.
- ◆ If reception is poor, you may need to install an outdoor aerial. To do so, connect an outdoor **FM** aerial to the **FM** socket on the rear of the system using a 75Ω coaxial cable (not supplied).

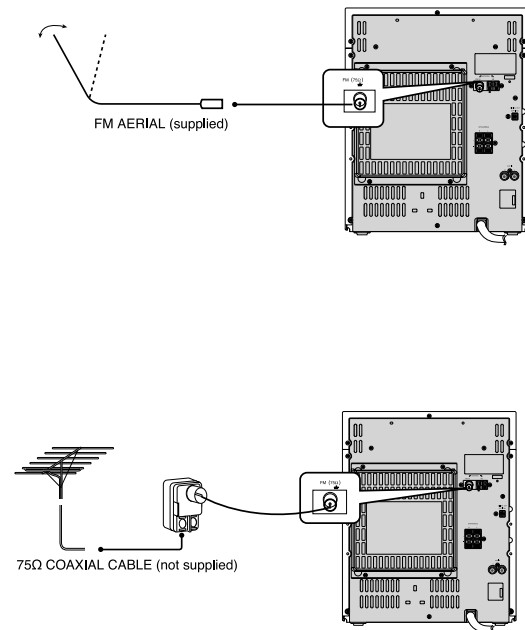

Connecting the SW Aerial (option)

How to connect a WIRE TYPE aerial.

- ◆ Spread the **SW** aerial out and attach the ends to a wall, in the position providing the best reception.
- ◆ If reception is poor (e.g. distance from transmitter too great, walls blocking the radio waves, etc.), install an outdoor aerial.

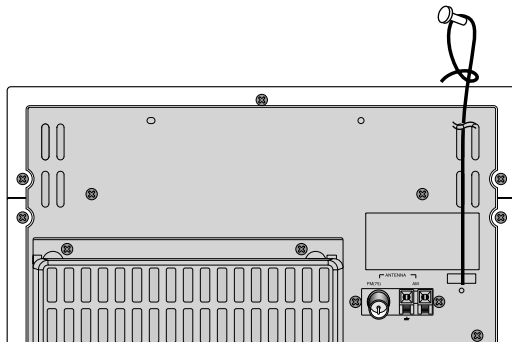

Demo/Dimmer function

GB

All functions available on the system can be viewed on the display and the display's brightness can be switched between "on" and "off".

- 1 Press the **Demo/Dimmer** button.
Result: All functions available on the system appear on the front panel display.
- Each of these are explained in detail in this guide. Please refer to the relevant section.
- 2 Press the **Demo/Dimmer** button again.
Result: The Dimmer function is selected and the display darkens.
- Press the **Demo/Dimmer** button once again to brighten the front panel display.
- 3 A display brightness control can only be performed while the system power is on.

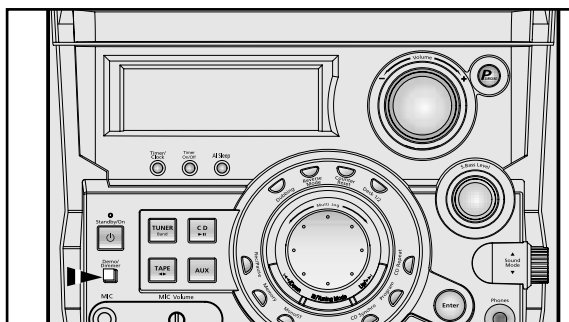

Setting the Clock

Your system is equipped with a clock which allows you to turn your system on and off automatically. You should set the clock:

- ◆ When you first purchase the mini-compact system
 - ◆ After a power failure
 - ◆ After unplugging the unit
- ☛ For each step, you have a few seconds to set the required options. If you exceed this time, you must start again.

- 1 Switch the system on by pressing **Standby/On**.
- 2 Press **Timer/Clock** twice.
Result: **CLOCK** is displayed.
- 3 Press **Enter**.
Result: The hour flashes.
- 4 **To... Turn the Multi Jog knob to the...**
Increase the hours Right
Decrease the hours Left
- 5 When the correct hour is displayed, press **Enter**.
Result: The minutes flash.
- 6 **To... Turn the Multi Jog knob to the...**
Increase the minutes Right
Decrease the minutes Left
- 7 When the correct time is displayed, press **Enter**.
Result: The clock starts and is displayed, even when the system is in standby mode.

- You can display the time, even when you are using another function, by pressing Timer/Clock once.
- ◆ You can also use Program/Set button on the remote control to instead Enter button in step 3, 5, 7.
- ◆ You can also use ◀◀ / ▶▶ buttons to instead Multi Jog knob in step 4, 6.

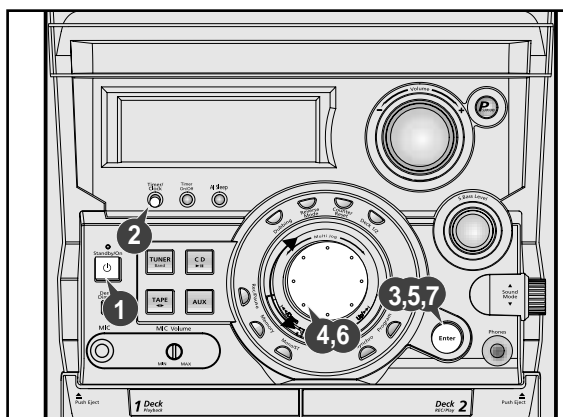

Loading and Changing Compact Discs

The CD disc changer can contain up to three 12 cm or 8 cm compact discs without using an adapter.

- ⚠ Never force the compact disc carousel when opening and closing the compartment.
Never press down or place objects on the carousel.
- Always treat your compact discs with care; refer, if necessary, to the section entitled "Precautions When Using Compact Discs" on page 24 .

- 1 Switch the system on by pressing **Standby/On**.
- 2 Press the **Open/Close** (▲) button on the front panel.
Result: The compartment opens.
- 3 Place one or two discs in the front slots of the carousel, with the label on the discs facing upwards.
⚠ Check that the compact disc has been correctly inserted in the holder before closing the compartment.
- 4 If you wish to load a third compact disc, press the **Disc Change** button on the front panel (or **Disc Skip** on the remote control).
Result: The carousel rotates by 120°.
- 5 Close the compartment by pressing the **Open/Close** (▲) button again.
➤ If you wish to start playing a disc directly, you can also proceed as follows.

To play...	Press...
Disc 1	CD (▶) or Disc 1
Disc 2	Disc 2
Disc 3	Disc 3

Result: The compartment closes automatically and the disc selected starts playing.

- 6 To change or unload the compact disc changer, repeat Steps 2 to 5.

- ⚠ Keep the compartment closed whenever you are not using it, to prevent dust from entering.
- You can load or unload compact discs when the radio, tape or auxiliary source function is selected.

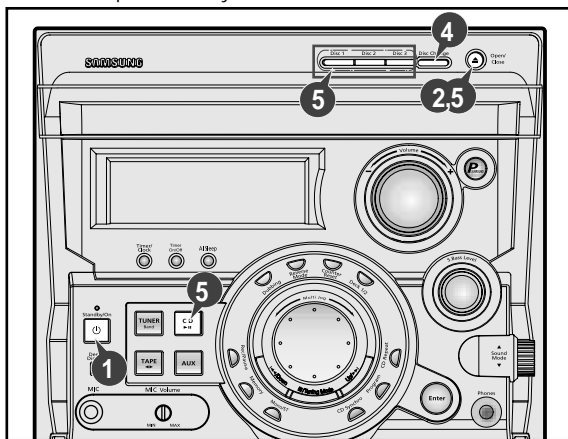

Listening to a Compact Disc

This unit has been designed to playback the CDs: Audio CD, CD Text, CD-R and CD-RW.
When you have loaded at least one compact disc into the player, you can start listening to it.
Continued use of irregular shape CDs (heart-shape, octagonal, etc.) can damage the unit.

- 1 Switch the system on by pressing **Standby/On**.
- 2 Select the CD function by pressing **CD** (▶||) on the front panel.
- 3 Load one or more discs.
- 4 Press **CD** (▶||) on the front panel or ▶|| on the remote control.
➤ If you have loaded more than one compact disc, they will be played in turn.
- 5 Adjust the volume as required by:
 - ◆ Turning the **Volume** knob on the front panel
 - or
 - ◆ Pressing the **VOL. +** or **-** buttons on the remote control
- 6 To pause temporarily during playback, press **CD** (▶||).
➤ Press **CD** (▶||) again to continue disc playback.
- 7 Press ■ when you have finished.

- When playing a disc, you can load new discs without stopping the current one. To do so, open the compartment by pressing **Disc Change** and load new discs in the other two vacant slots (not the one containing the disc that you are playing). You cannot rotate the carousel during playback.
- ◆ When no discs are loaded, the "NO DISC" indication is displayed.
- ◆ The CD player stops automatically after playing the three discs, if the CD REPEAT function has not been selected.

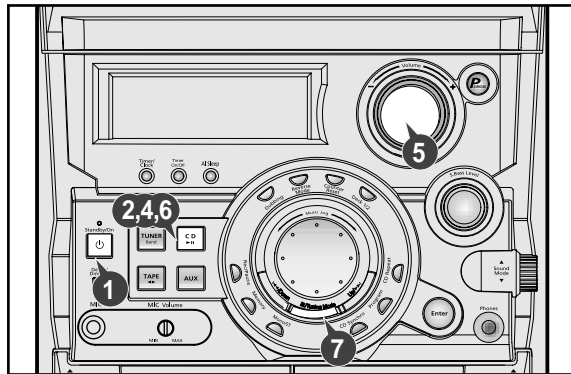

When playing a CD-R or CD-RW

User-edited CD-Rs (Recordable) and CD-RWs (Rewritable) can be played back only if they are already "finalized".

- You can play back your original CD-Rs or CD-RWs recorded in music CD format. (However, they may not be played back depending on their characteristics or recording conditions.)
- Some CD-Rs or CD-RWs may not be played back on this unit because of their disc characteristics, damage or stain on them, or if the player's lens is dirty.
- CD-RWs may require a longer readout time. (This is caused by the fact that the reflectance of CD-RWs is lower than for regular CDs.)



Selecting a CD in the Disc changer

GB

The CD function is automatically selected when Disc Skip is pushed.

To select a specific disc, press the corresponding Disc (1, 2, 3) button on the front panel or Disc Skip on the remote control, until the required disc indicator flashes.

Result: All the discs will be played in turn, starting with the one selected.

- If you wish to play the current disc only, press Repeat on the front panel one or more times, until **1 CD** is displayed.
- If you use the Disc (1, 2, 3) function when listening to the radio or to a tape, the system switches automatically to the CD mode.
- If the disc selected is not loaded, the next disc is played automatically.

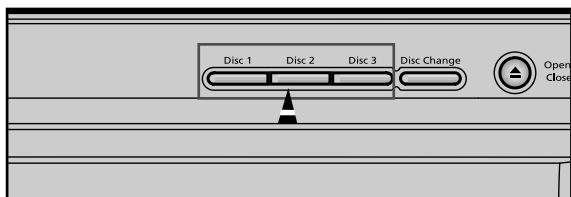

Searching for a Specific Music Passage on a CD

When listening to a compact disc, you can quickly search for a specific music passage on a track.

- It is recommended that you turn the volume down before using this function.

To search through the tracks...	Press and hold down...
Forwards	▶▶ for at least one second
Backwards	◀◀ for at least one second

You can also press and hold down ◀◀ / ▶▶ on the front panel to auto search through the tracks.

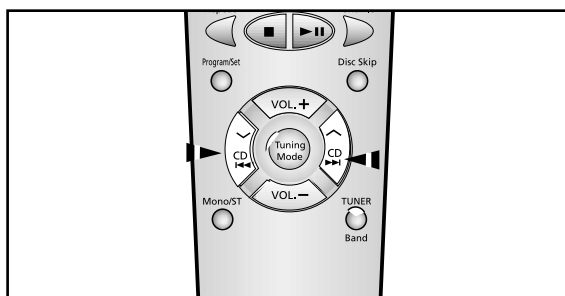

Selecting a Track

You can select the track you wish to listen to, either when the compact disc player is stopped or when a disc is playing.

To start playback at the beginning of the... Turn the Multi Jog knob...

Next track	One notch to the right
Current track	One notch to the left
Previous track	Two notches to the left
Track of your choice	The appropriate number of notches to the right or to the left

- You can also use the ◀◀ and ▶▶ buttons on the front panel, or the ◀◀ and ▶▶ buttons on the remote control to select a track.

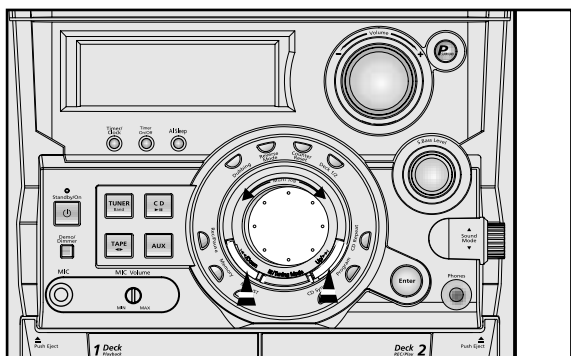

Shuffle Play Function

You can listen to the tracks on a compact disc in a different order each time, as the various tracks will be selected automatically in a random sequence.

- 1 Press the **Shuffle** button.
Result: The SHUFFLE indication appears and all the tracks are played in a random order. Both the track number and the playing time are displayed.
- 2 When playing tracks in a random order, you can:
 - Move on to the next track (selected at random) by pressing ◀◀ / ▶▶ or turning **Multi Jog** one notch to the right
 - Search quickly for a specific point in the current track by pressing ◀◀ / ▶▶ or turning **Multi Jog** one notch to the left
- 3 When you have finished the random playback, press ■ or press the **Shuffle** button again.

- Repeat and CD Synchro function are not available in Shuffle playing mode.

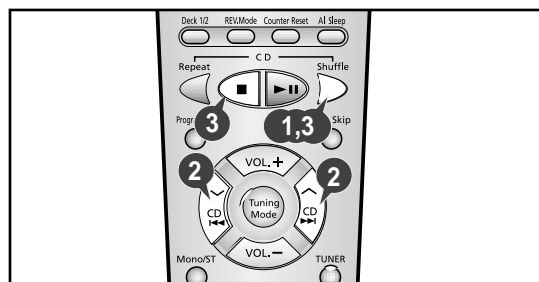

Repeating One or All Tracks on the Compact Discs

You can repeat indefinitely:

- ◆ A specific track on a compact disc.
- ◆ All tracks on the compact disc selected.
- ◆ All discs loaded in the carousel

- 1 **To repeat...** **Press CD Repeat on the Front Panel one or more times until...**
 The current track indefinitely **REPEAT 1** is displayed
 The selected disc **REPEAT 1 CD** is displayed
 All discs loaded **REPEAT ALL CD** is displayed
- 2 When you wish to stop the Repeat function, press **CD Repeat** until **ALL CD** or **1 CD** is displayed, or press **■**.

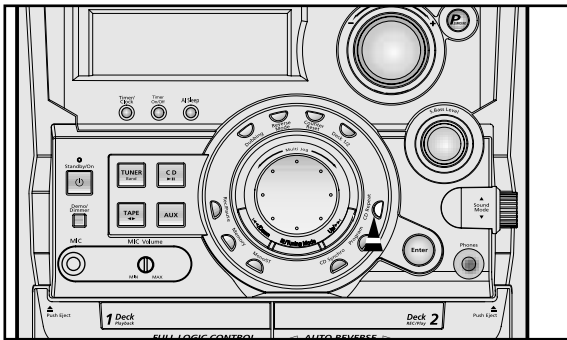

Programming the Order of Playback

You can decide:

- ◆ The order in which you listen to the tracks on the discs loaded
- ◆ Which tracks you do not wish to listen to
- ◆ You can program up to 24 tracks.
- ◆ You must stop the compact disc player before selecting the tracks.
- ◆ This feature can be combined with the Repeat function.

- 1 If the CD function is selected, stop the player by pressing **■**.

- 2 Load the selected CDs.

- 3 Press **Program**.
Result: The following indications are displayed:

PRGM 01PR 01 --

(01 = Program no., DI = Disc no., -- = Track no. on the disc)

- 4 If necessary, select the disc containing the required track by pressing the corresponding **Disc (1, 2, 3)** button.

- 5 Select the required track by turning the **Multi Jog** knob:

- ◆ To the left to move back through the tracks
- ◆ To the right to move forward through the tracks

- 6 Press **Program** to confirm your selection.

Result: The selection is stored and **PRGM 02PR 01 --** is displayed.

- 7 To select other tracks, repeat Steps 4 to 6.

- 8 Press **CD (▶||)** to listen to the track selection in the order programmed.

- 9

To...	Turn the Multi Jog knob...
Listen to the current track again	One notch to the left
Listen to the previous track	Two notches to the left
Listen to the next track	One notch to the right
Skip forwards or backwards one	The appropriate number of notches to the right or to the left
or more tracks	

- 10 To cancel the selection, press **■**.

- ◆ Once if the compact disc player is stopped
Result: **PRGM** is no longer displayed.

- ◆ If you open the compartment, the selection is cancelled.
- ◆ If you select the number of a disc which is not loaded or a track which does not exist on the CD, the selection skips to the next programmed track.
- ◆ You can also use the **◀◀ / ▶▶** buttons to select the required tracks in step 5, 9.

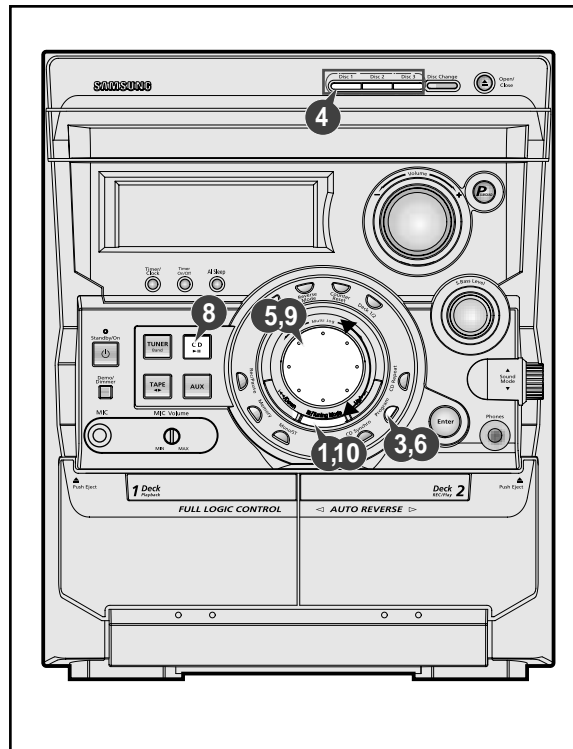

Checking or Changing Programmed Tracks

GB

You can check or change your selection of tracks at any time.

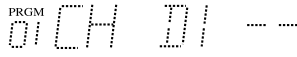
- 1 Press **■** once if you have started listening to the selection.
- 2 Press **Program**.
Result: The following indications are displayed:

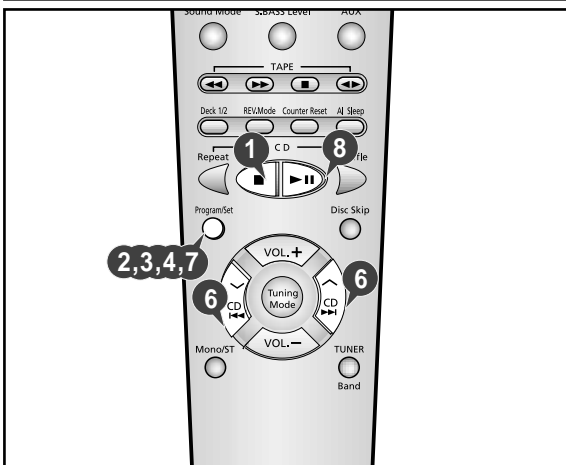
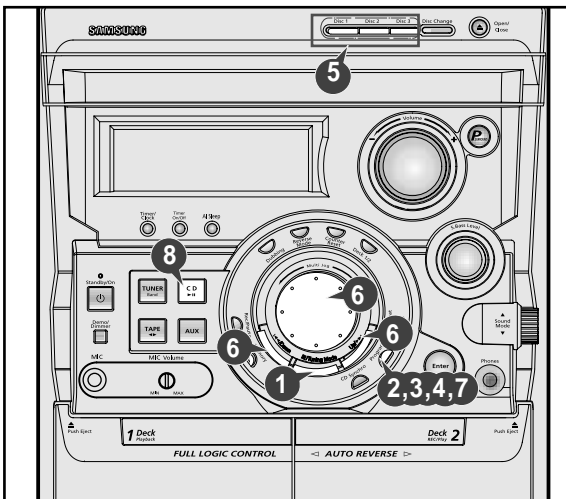
 (CH = Check, 01=Program No, DI = Disc No, -- = Track No on the disc)
 ➤ If you have already programmed 24 tracks, **CH** is displayed instead of **PR** when you press **Program**.
- 3 Press **Program** again.
Result: The first track selected is displayed, together with the letter **CH** (Change).
- 4 Press **Program** one or more times until the track to be changed is displayed.
- 5 If necessary, press the corresponding **Disc (1, 2, 3)** button to change discs.
- 6 Press **◀▶** and **▶▶** or turn **Multi Jog** to select a different track.
- 7 Press **Program** to confirm your change.
- 8 Press **CD (▶▶)** to start listening to the selection.
Result: The first track selected is played.



Searching for and Storing the Radio Stations

You can store up to:

- ◆ 15 FM stations
- ◆ 15 AM stations (or 8 MW and 7 LW stations) or
- ◆ 15 AM stations (5 MW, 5 SW1, and 5 SW2 Stations)

- 1 Switch the system on by pressing **Standby/On**.
- 2 Select the **TUNER** function by pressing **TUNER**.
- 3 Select the required frequency band by pressing **TUNER (Band)** again on the front panel or **Tuner (Band)** on the remote control.
Result: The appropriate indication is displayed:

◆ FM	Frequency Modulation
◆ AM(MW)	Medium Wave
◆ SW1(Optional)	Short Wave
◆ SW2(Optional)	Short Wave
◆ LW(Optional)	Long Wave
- 4 To search for a station... Press Tuning Mode

Manually	One or more times until MANUAL is displayed.
Automatically	One or more times until AUTO is displayed.
- 5 Select the station to be stored by:
 - ◆ Turning the **Multi Jog** knob to the right or to the left to increase or decrease the frequency respectively
 - or
 - ◆ Pressing **Tuning** **∨** or **∧** on the remote control
 - ◆ To scroll through the frequencies faster when searching manually, hold down the **Tuning Down** or **Up** buttons.
 - ◆ The automatic search procedure may stop on a frequency that does not correspond to a radio station. If this happens, use the manual search mode.
- 6 Adjust the volume by:
 - ◆ Turning the **Volume** knob on the front panel
 - or
 - ◆ Pressing the **VOL. +** or **-** buttons on the remote control
- 7 Select the stereo or mono mode by pressing **Mono/ST**.

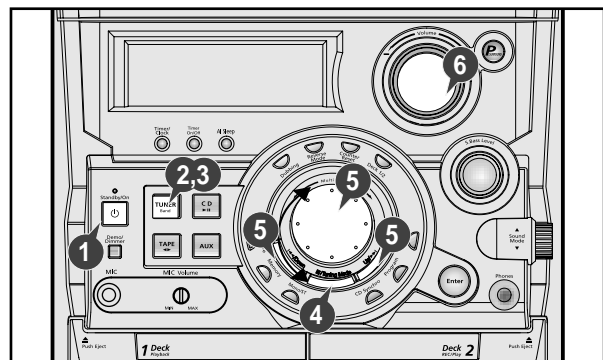

Searching for and Storing the Radio Stations (continued)

- 8 If you do not want to store the radio station found, revert to Step 4 and search for another station.
 Otherwise:
- Press **Memory**.
Result: The **PRGM** is displayed for a few seconds.
 - Press **Tuning Down** and **Up** to assign a program number between **1** and **15**.
 - Press **Memory** to store the radio station.
Result: **PRGM** is no longer flashed and the station is stored.
- 9 To store any other radio frequencies required, repeat Steps 3 to 8.

- The PROGRAM function can be used to assign a new station to an existing program number.
 ➤ You can also use Program/Set button on the remote control to instead Memory button in step 8.

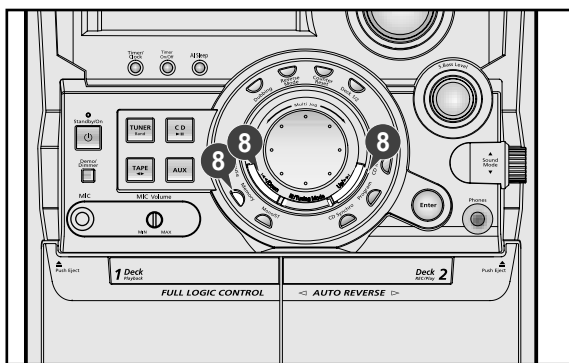

Selecting a Stored Station

You can listen to a stored radio station as follows:

- Switch the system on by pressing **Standby/On**.
- Select the **TUNER** function by pressing **Tuner** on remote control.
- Select the required frequency band by pressing **Tuner (Band)** on the remote control or **TUNER (Band)** again on the front panel.
- Press the **Tuning Mode** button on the front panel of the unit, or the **Tuning Mode** button on the remote control until "**PRESET**" is displayed.
- Turning **Multi jog** on the front panel left or right until the desired station is found or press **◀/▶** to select the desired station. or Select the desired station by pressing the station number stored, using the **Tuning** **∨** or **∧** button on the remote control.
Result: The desired station is now received.

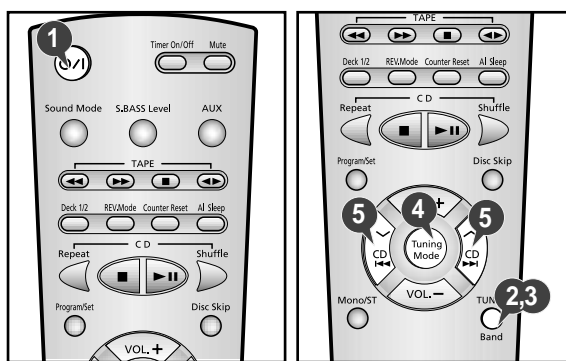

In Tuner mode

- In manual tuning mode, you can use **Multi Jog** or **◀/▶** button to manual search a radio station.
- During Tuner auto searching, press **■** button to stop auto searching.
- In Preset tuning mode, you can use **Multi Jog** or **◀/▶** button to search a stored radio station.

Improving Radio Reception

You can improve the quality of radio reception by:

- Rotating the FM or AM(MW) aerial
- Testing the positions of the FM and AM(MW) aerials before fixing them permanently

- If reception from a specific FM radio station is poor, press **Mono/ST** to switch from stereo mode to mono. The quality of the sound will be improved.

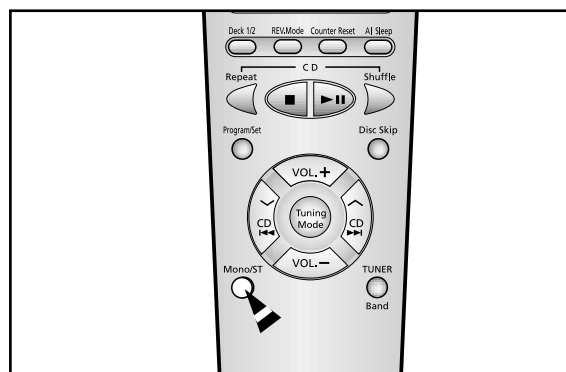

Listening to a Cassette

GB



➤ Always treat your cassettes with care; refer, if necessary, to the section entitled "Precautions When Using Audio Cassettes" on page 22.

- 1 Switch the system on by pressing the **Standby/On** button.
- 2 Select the TAPE function by pressing **TAPE** on the front panel.
- 3 Open either cassette deck 1 or 2 by pushing and releasing the deck cover where **PUSH EJECT** (▲) is written.
- 4 Insert the pre-recorded cassette with the open edge of the tape facing downward.
- 5 Close the deck by pushing on it until it clicks into place.
Result: Depending on the deck selected, the **1** or **2** indication is displayed in front of the counter number.
- 6 If you have inserted two cassettes, press **Deck 1/2** on the front panel or directly the **Deck 1/2** button on the remote control to select the cassette to be played.
Result: Depending on the deck selected, the TAPE 1 or TAPE 2 indication is displayed.

To listen to...	Press ...
Side A	TAPE (◀▶) once
Side B	TAPE (▶▶) twice

Result: The cassette starts playing.

- 8 When the cassette is stopped, select one of the following functions as required.

Main Unit

To...	Press...
Rewind the cassette	◀◀
Fast-forward the cassette	▶▶

Remote Control

To...	Press ...
Rewind the cassette	◀◀
Fast-forward the cassette	◀◀

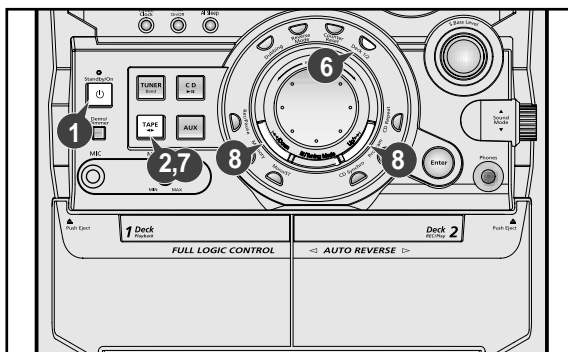

CD Synchro Record Feature

You can record a compact disc on a cassette in two different ways:

- ◆ Synchronised recording
- ◆ Direct recording

This feature enables you to synchronize the start of the recording with the start of the disc or track of your choice.

- 1 Switch the system on by pressing **Standby/On**.
- 2 Insert a blank cassette in Deck 2.
- 3 Select the CD function by pressing **CD** on the front panel.
- 4 Load a compact disc.
- 5 Select the required disc.
- 6 Select the required track and press **CD Synchro** or press **CD Synchro** directly to start recording at the beginning of the disc.
Result: **REC** is displayed and recording starts.
- 7 To stop recording, press ■.

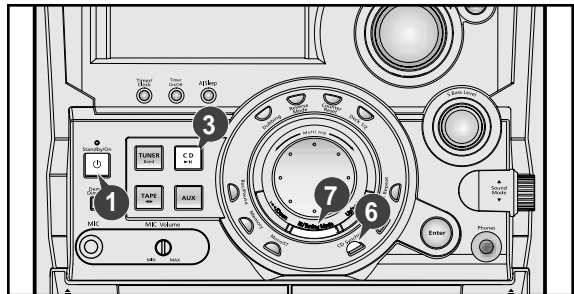

Recording a Compact Disc

The direct recording mode enables you to start recording with any track on the compact disc.

- ◆ You can only record on cassettes in Deck 2.
- ◆ You do not need to adjust the volume, as it has no effect on the recording.

- 1 Switch your system on by pressing **Standby/On**.
- 2 Insert a blank cassette in Deck 2.
- 3 Select the CD function by pressing **CD** on the front panel.
- 4 Load the compact disc.
- 5 Select the required disc.
- 6 Select the required track on the compact disc and press ▶|| on the front panel or ▶|| on the remote control to set the compact disc player to Pause mode.
- 7 Press the **REC/Pause**.
Result: **REC** is displayed.
- 8 Press the ▶|| to start playing the track.
Result: The track is recorded on the cassette.
- 9 To stop recording, press ■.

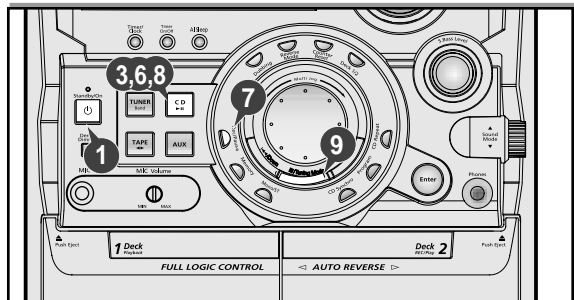

Recording a Radio Program

You can record a radio program of your choice.

- ◆ You can only record on cassettes in Deck 2.
- ◆ You do not need to adjust the volume, as it has no effect on the recording.

- 1 Switch the system on by pressing **Standby/On**.
- 2 Insert a blank cassette in Deck 2.
- 3 Select the **TUNER** function by pressing **TUNER**.
- 4 Select the radio station that you wish to record by pressing **Tuning** \wedge or \vee on the remote control or by press the **Tuning Down** or **Up** on the front panel.
- 5 Press **REC/Pause**.
Result: **REC** is displayed in red and recording starts.
- 6 To stop recording, press \blacksquare .

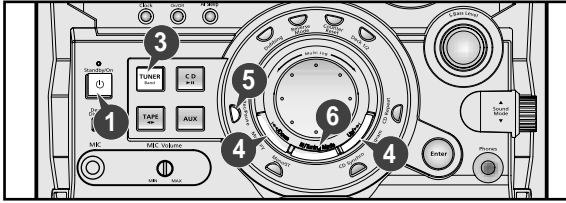

Copying a Cassette (Dubbing)

You can copy a cassette from Deck 1 to Deck 2. Two options are available:

- ◆ Normal speed dubbing
- ◆ You do not need to adjust the volume, as it has no effect on the recording.
- ◆ Take care not to insert the tape to be copied in Deck 2, as it will be erased when you start recording.

- 1 Switch your system on by pressing **Standby/On**.
 - 2 Insert a blank cassette in Deck 2.
 - 3 Insert the tape to be copied in Deck 1.
 - 4 **To copy a cassette at... Press...**
Normal speed Dubbing
- Result: The appropriate indications are displayed and the cassette in Deck 1 is copied to the cassette in Deck 2.
- 5 To stop dubbing, press \blacksquare .

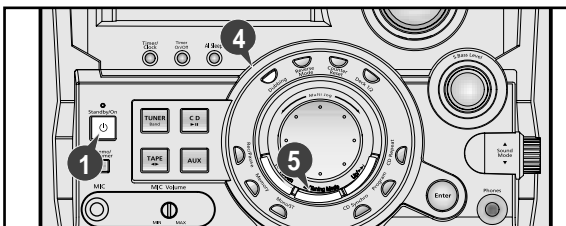

Selecting the Cassette Playback Mode (Deck 2 Only)

Your mini-compact system has three cassette playback modes which enable you to listen to both sides of a cassette automatically.
Press **REV.Mode** until the appropriate symbol is displayed.



When the display indicates... The mini-compact system plays back...

- One side of the selected cassette and then stops.
- One side of the cassette. The other side of the cassette and then stops.
- Both sides of the cassette indefinitely until you press stop.

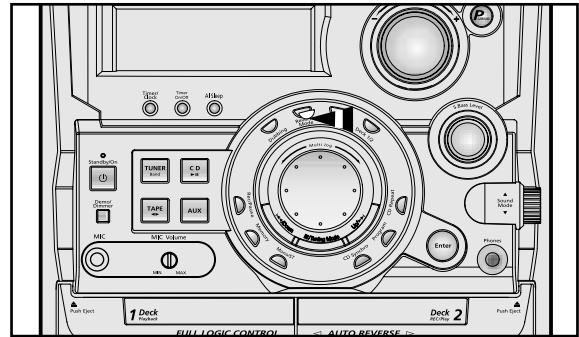

Tape Counter

When playing a cassette in one of the cassette decks, a counter is displayed to enable you to take note of the counter value at the start of each track to start playback at the beginning of the track to which you wish to listen.

- Before starting to record a cassette for which you wish to take note of the counter values at the beginning of each track, reset the counter by pressing Counter Reset .

- Each cassette deck has a separate counter.

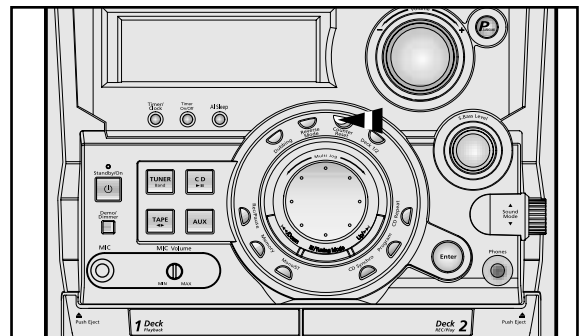

Timer Function

GB

The timer enables you to switch the system on or off at specific times.

Example: You wish to wake up to music every morning.

➤ If you no longer want the system to be switched on or off automatically, you must cancel the timer.

- ◆ Before setting the timer, check that the current time is correct.
- ◆ For each step, you have a few seconds to set the required options. If you exceed this time, you must start again.

- 1 Switch the system on by pressing **Standby/On**.
- 2 Press **Timer/Clock** until **TIMER** is displayed.
- 3 Press **Enter**.
Result: **ON TIME** is displayed (instead of the equalizer symbols) for a few seconds, followed by any switch-on time already set; you can set the timer switch-on time.
- 4 Set the timer switch-on time.
 - a Set the hour by tuning the **Multi Jog** knob to the right or to the left.
 - b Press **Enter**.
Result: The minutes flash.
 - c Set the minutes by tuning the **Multi Jog** knob to the right or to the left.
 - d Press **Enter**.
Result: **OFF TIME** is displayed (instead of the equalizer symbols) for a few seconds, followed by any switch-off time already set; you can now set the timer switch-off time.
- 5 Set the timer switch-off time.
 - a Set the hour by tuning the **Multi Jog** knob to the right or to the left.
 - b Press **Enter**.
Result: The minutes flash.
 - c Set the minutes by tuning the **Multi Jog** knob to the right or to the left.
 - d Press **Enter**.
Result: **VOL XX** is displayed, where **XX** corresponds to the volume already set.
- 6 Press **Tuning Down** and **Up** to adjust the volume level and press **Enter**.
Result: The source to be selected is displayed.
- 7 Turn the **Multi Jog** knob to select the source to be played when the system switches on.

If you select...	You must also...
TAPE (cassette)	Insert a recorded cassette in one of the decks before setting the system to standby.
TUNER (radio)	<ol style="list-style-type: none"> a Press Enter. b Select the FM or AM frequency band by tuning the Multi Jog knob to the right or to the left. c Press Enter. d Select a preset station by tuning the Multi Jog knob to the right or to the left.
CD (compact disc)	<ol style="list-style-type: none"> a Load one or more compact discs. b Select the required disc.
- 8 Press **Enter** to confirm the timer.
- 9 Press **Standby/On** to set the system to standby mode.
Result: **⏻** is displayed to the bottom left of the time, indicating that the timer has been set. The system will switch on and off automatically at the required times.

➤ If the timer switch on and off times are identical, the word **ERROR** is displayed.

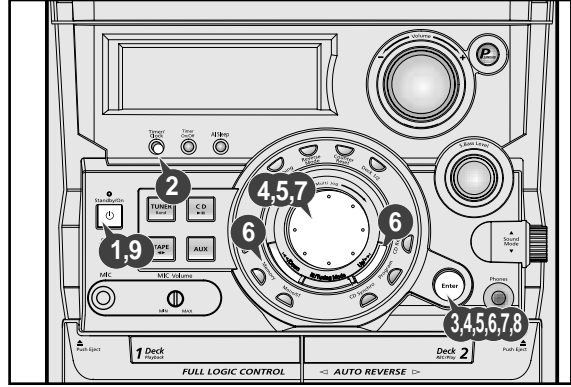

To set the timer function

- ◆ You may use **Multi Jog** or **◀▶** buttons to adjust in step 4, 5, 6, 7.
- ◆ You can also use **Program/Set** button on the remote control to instead **Enter** button in step 3, 4, 5, 6, 7, 8.

Cancelling the Timer

After having set the timer, it will start automatically as shown by the **TIMER** indication on the display. If you no longer wish to use the timer, you must cancel it.

➤ You can stop the timer at any time (system on or in standby mode).

To...	Press Timer-On/Off...
Cancel the timer	Once. Result: ⏻ is no longer displayed.
Restart the timer	Twice. Result: ⏻ is displayed again.

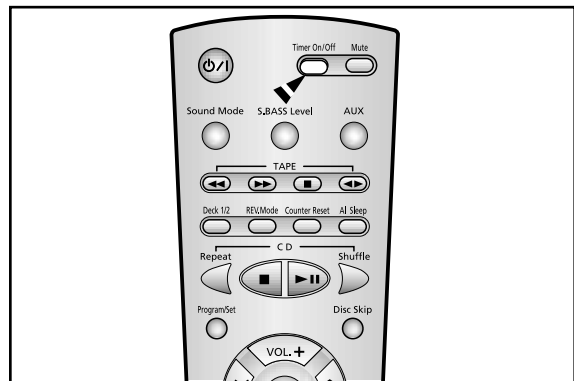

Mute Function

You can turn the sound off temporarily on your system.
Example: You wish to answer a telephone call.

- 1 Press **Mute**.
- 2 To switch the sound back on (at the same volume as before), press **Mute** again or the **Volume** buttons.



Power Surround Function

Your mini-compact system is equipped with the function of Power Surround.
 The Power Surround replaces conventional stereo sound with a wider and more true-to-life sound. It creates the feeling of being right at the centre of the music and being surrounded by total music sound.

- Press **P. Surround** button on the front panel until the required option is selected. Each time the **P. Surround** button is pressed, "**P.SURR.**" is selected or cancelled in this order.

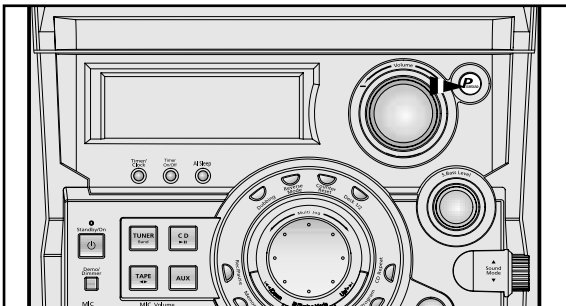

Selecting Sound Mode

our mini-compact system is equipped with a preset equalizer that allows you to choose the most appropriate balance between treble and bass frequencies, according to the type of music you are listening to.

This model provides D.S.P modes so that you can enjoy virtually original sound.

Turn **Sound Mode (Latin Sound)** on the front panel or Press **Sound Mode (Latin Sound)** on the remote control until the required option is selected.

To obtain a...	Select...
Normal balance (linear)	PASS
Balance suitable for pop music	POP
Balance suitable for rock music	ROCK
Balance suitable for classic music	CLASSIC
Balance suitable for hall	HALL
Balance suitable for live	LIVE
Balance suitable for cinema	CINEMA
or	
Normal balance (linear)	PASS
Balance suitable for pop music	POP
Balance suitable for rock music	ROCK
Balance suitable for classic music	CLASSIC
Balance suitable for salsa music	SALSA
Balance suitable for samba music	SAMBA
Balance suitable for lambada music	LAMBADA

➤ **Latin Sound** can be selected in **Latin American**

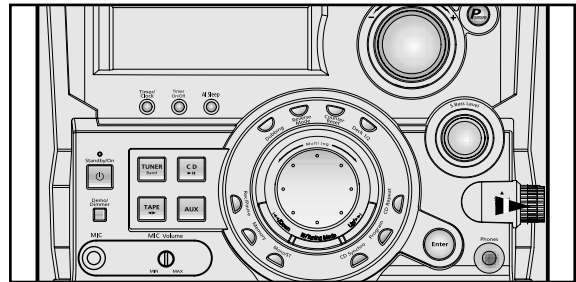

Setting the System to Switch off Automatically

GB

While listening to a compact disc or a cassette, you can set the system to switch off automatically

Example: You wish to go to sleep to music.

- 1 Press **AI Sleep**.
Result: playback starts and the following indications are displayed:
90 MIN
- 2 Press **AI Sleep** one or more times to indicate how long the system should continue playing before it switches off:

(AI SLEEP)	→ 90 MIN	→ 60 MIN	→ 45 MIN
OFF	← 15 MIN	← 30 MIN	←

 - At any time, you can:
 - ◆ Check the remaining time by pressing **AI Off/Sleep**
 - ◆ Change the remaining time by repeating Steps 1 and 2
- 3 Press **AI Sleep** one or more times until **AI SLEEP** is displayed.
Result: The system will automatically switch off at the end of the disc or cassette.
- 4 To cancel SLEEP or AI OFF function, press **AI Sleep** one or more times until **OFF** is display.

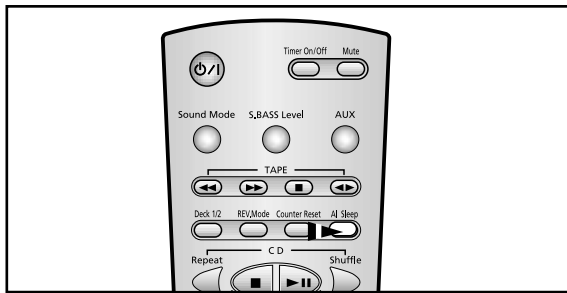

Connecting Headphones

You can connect a set of headphones to your mini-compact system so that you can listen to music or radio programmers without disturbing other people in the room. The earphones must have a 3.5 mm jack or an appropriate adapter.

Connect the headphones to the **Phones** jack on the front panel.
Result: The loudspeakers are no longer used to output the sound.

⚠ Prolonged use of headphones at a high volume may damage your hearing.

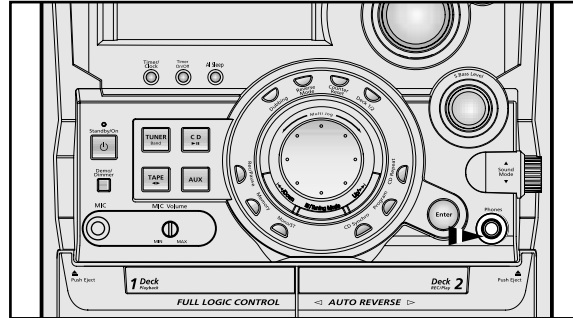

Super Bass Level

Your mini-compact system has a bass amplification function called S.Bass (Super Bass Sound). This function makes the sound more powerful and real.

- 1 Turn **S.Bass Level** knob on the front panel or press the **S.BASS Level** button on the remote control.
Press the button on the remote control repeatedly to select

OFF	→ S, BASS1	→ S, BASS 2	→ S, BASS3	→ S, BASS4
-----	------------	-------------	------------	------------

or turn the knob on the front panel repeatedly to select
"OFF ↔ S, BASS1 ↔ S, BASS 2 ↔ S, BASS3 ↔ S, BASS4".
- 2 You can select the level of low tones you desired.

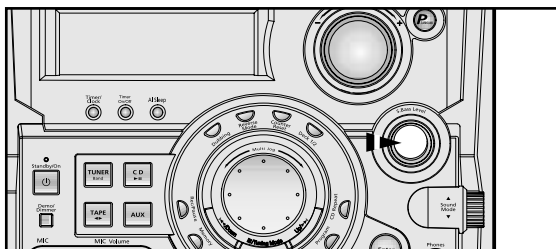

Microphone Function (option)

The microphone enables the user to mix in his or her vocals to sing-along with the music or recording .

Preparation
Plug the microphone with a 6.3mm mic jack into microphone terminal.

- 1 Turn the **MIC Mixing** knob to adjust the mic mixing.

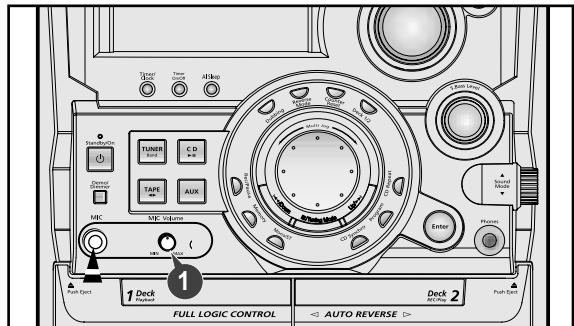

Safety Precautions

The following diagrams illustrate the precautions to be taken when using or moving your mini-compact system.

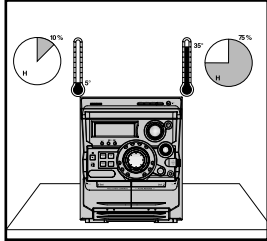

Ambient operating conditions:
 Ambient temperature 5°C-35°C
 Humidity 10-75%

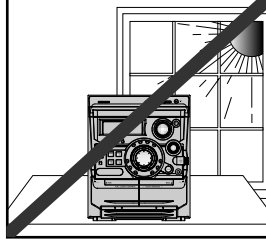

Do not expose the unit to direct sun radiation or other heat sources. This could lead to overheating and malfunction of the unit.

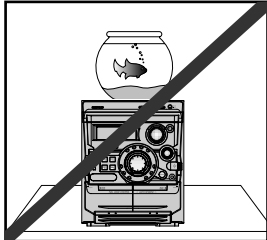

Do not place potted plants or vases on top of the unit. Moisture entering the unit could lead to dangerous electric shock and can cause equipment damage. In such events immediately disconnect the main plug from the socket.

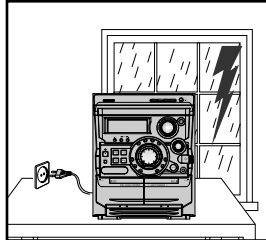

During thunderstorms, disconnect the main plug from the socket. Main voltage peaks due to lightning could damage the unit.

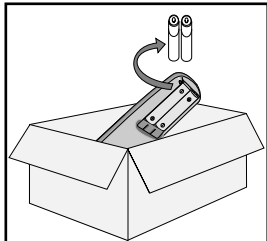

Remove the batteries from the remote control, if not used for any extended period. Leaking batteries can cause serious damage to the remote control.

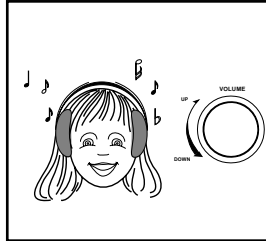

When using headphones, take care not to listen at excessive volumes. Extended use of headphones at high volumes will lead to hearing damage.

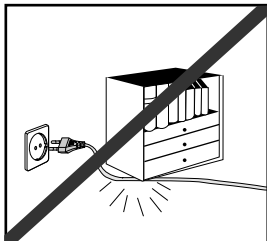

Do not place heavy items on the main lead. Main cable damage can lead to damage of the equipment (fire hazard) and can cause electric shock.

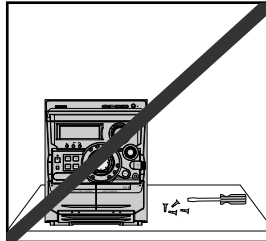

Do not remove any equipment panels. The inside of the unit contains live components, which cause electric shock.

Cleaning Your Mini-Compact System



To obtain the best possible results from your mini-compact system, you must clean the following elements regularly:

- ◆ The outer casing
- ◆ The compact disc player
- ◆ The cassette players (heads, rollers and drive capstans)
- ☛ Always unplug the system from the wall outlet:
 - ◆ Before cleaning it
 - ◆ If you are not going to be using it for a long time

Outer Casing

Clean the outer casing regularly using a soft cloth and a light detergent. Do not use abrasive powders, liquids or aerosol cleaners. Never let any liquids get into the system.

Compact Disc Player

- 1 Before playing a compact disc, clean it with a special CD cleaning agent. Do not use the same cleaning agents as for vinyl LP records. Carefully wipe the disc from the centre outward.
- 2 Regularly clean the player with a special cleaning disc (available from your local dealer).

Tape Decks

- 1 Press **Push Eject** (▲) to open the cassette deck.
- 2 Use a cotton bud and a special cassette cleaning agent to clean the:
 - ◆ Head (1)
 - ◆ Rollers (2)
 - ◆ Drive capstans (3)

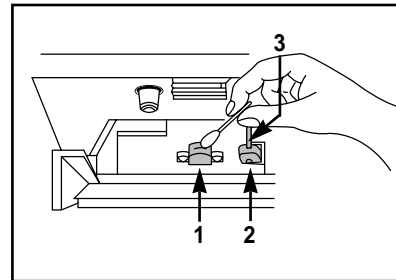

- ☛ If you will not be using the remote control for a long time, remove the batteries to prevent corrosion.
- ◆ Although your system is very hard-wearing, it should not be used in an excessively dusty environment or subjected to shocks or extreme heat (close to heating appliances or in direct sunlight, etc.).
- ◆ If the unit emits an unpleasant odor when in use, unplug it from the main supply and contact the after-sales service.

Precautions When Using Compact Discs

GB

- ◆ Handle your compact discs with care. Always hold them by the edges to avoid leaving fingerprints on the shiny surface.
- ◆ When you have finished playing a compact disc, always put it back in its case.
- ◆ Do not fix paper or adhesive tape to the discs and do not write on the label.
- ◆ Clean them with a special-purpose cloth.
- ◆ Store your compact discs in a clean place, out of direct sunlight, where they will not be exposed to high temperatures.
- ◆ Always use compact discs marked .

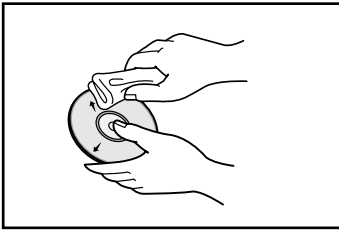

Precautions When Using Audio Cassettes

- ◆ Check that the tape in the cassette is sufficiently taut.
- ◆ To prevent erasing a cassette that you wish to keep, remove the safety tab on the upper edge of the cassette. To record a cassette, where the tab has been broken, simply cover the opening with adhesive tape.
- ◆ When you have finished playing a cassette, always put it back in its case.
- ◆ Store your cassettes in a clean place, out of direct sunlight, where they will not be exposed to high temperatures.
- ◆ Avoid using 120-minute cassettes as they place unnecessary strain on the tape mechanism.

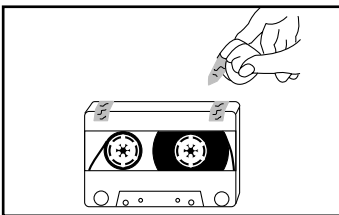
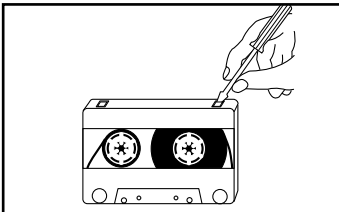
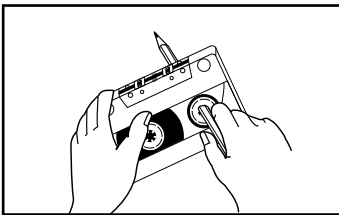

Before Contacting the After-Sales Service

It always takes a little time to become familiar with a new appliance. If you have any of the problems listed below, try the solutions given. They may save you the time and inconvenience of an unnecessary service call.

Problem	Checks/Explanation	
The system does not work	<ul style="list-style-type: none"> • The main lead is not correctly plugged into a wall socket or the wall socket is not switched on. • The remote control batteries need replacing or the polarity has not been respected. • The Standby/On button has not been pressed. 	
G E N E R A L	There is no sound	<ul style="list-style-type: none"> • The volume has been completely turned down. • The correct function (TUNER, CD, TAPE, AUX) has not been selected. • You have connected a set of earphones. • The loudspeaker wires have been disconnected. • The MUTE button has been pressed.
	The Timer does not work	<ul style="list-style-type: none"> • The timer has been stopped by pressing Timer On/Off.
C D	In case it does not work, even the action is taken as above.	<ul style="list-style-type: none"> • Press the P.Surround button for 5 seconds in power 'OFF'(standby), then it is returned the original position (RESET)
	The compact disc player does not start playing	<ul style="list-style-type: none"> • The CD function has not been selected. • The disc has been inserted face down or is either dirty or scratched. • The laser sensor is dirty or dusty. • The system has not been installed on a flat, horizontal surface. • Condensation has formed in the player; leave the system in a warm, airy room for at least one hour.
C A S S E T T E S	The tape does not start playing	<ul style="list-style-type: none"> • The TAPE function has not been selected. • The cassette has not been inserted correctly. • The cassette player has not been closed. • The tape is either slack or broken.
	The volume falls off The cassette is not erased correctly There is excessive wow and flutter	<ul style="list-style-type: none"> • The audio heads are dirty. • The rollers or drive capstans are dirty. • The tape is worn.
R A D I O	Reception is poor or no radio stations are received at all	<ul style="list-style-type: none"> • The TUNER function has not been selected. • The radio frequency has not been correctly selected. • The aerial has been disconnected or is not facing the right way. Turn it until you find the best orientation. • You are in a building that blocks radio waves; you must use an outside aerial.

If the above guidelines do not allow you to solve the problem, take a note of:

- ◆ The model and serial numbers, normally printed on the rear of the system
- ◆ Your warranty details
- ◆ A clear description of the problem

Then contact your local dealer or SAMSUNG after-sales service.

Technical Specifications



SAMSUNG strives to improve its products at all times. Both the design specifications and these user instructions are thus subject to change without notice.

RADIO

LW(option)

Usable sensitivity 60 dB

SW(option)

Usable sensitivity 40 dB

AM (MW)

Tuning range 522 - 1611KHz

Signal/noise ratio 40 dB

Usable sensitivity 54 dB

Total harmonic distortion 2 %

FM

Tuning range 87.5 - 108MHz

Signal/noise ratio 62 dB

Usable sensitivity 10 dB

Total harmonic distortion 0.3 %

COMPACT DISC PLAYER

Capacity 3 discs

Frequency range 20 Hz - 20 KHz (± 1 dB)

Signal/noise ratio 90 dB (at 1 KHz) with filter

Distortion 0.05 % (at 1 KHz)

Channel separation 74 dB

Disc sizes Diameter: 120 or 80 mm. Thickness: 1.2 mm

TAPE DECK

Frequency range 125 Hz ~ 12 KHz

Signal/noise ratio 40 dB

Channel separation 35 dB

Erasing effect 60 dB

AMPLIFIER

Output power (6 Ω) 70 Watts / Ch RMS, (total harmonic distortion: 10 %)MAX-B550

100 Watts / Ch RMS, (total harmonic distortion: 10 %)MAX-B570

Channel separation 50 dB

Signal/noise ratio 75 dB

GENERAL

Dimensions 270 (W) x 332 (H) x 410 (D) mm

THIS APPLIANCE IS MANUFACTURED BY:

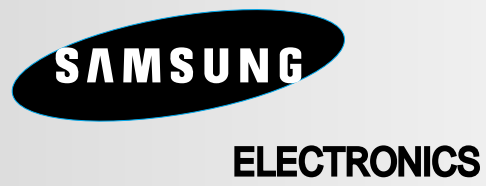

AH68-01033J